

N Series

N 系列产品是按照 MIL-C-39012、IEC169-16 详细规范研制生产的一种具有螺纹结构的中大功率连接器、具有抗震性强、可靠性高、机械和电器性能优良等特点，广泛用于无线电设备和仪器中连接射频同轴电缆用。

The N series are very popular screw-coupling middle-power coaxial connectors, which are developed and manufactured according to the specifications of MIL-C-39012, IEC 169-16. They have the characteristics of vibration -proof, high reliability, superior electrical and mechanical properties, are widely used to connect with RF coaxial cables in wireless equipment and instruments.



金润信电子科技有限公司

主要技术特性 Technical Characteristics:		
环境温度范围 Temperature range	-65~+165℃	
电气性能 Electrical Characteristics		
特征阻抗 Characteristic impedance	50Ω	
工作电压 Working voltage	1000V max(有效值)	
频率范围 Frequency range	0~11GHz	
介质耐压 Dielectric withstanding voltage	海平面 at sea level: 1500V(volts RMS)	
接触电阻 Contact resistance	内导体 center contact	≤10.0mΩ
	外导体 Outer contact	≤5.0mΩ
绝缘电阻 Insulation resistance	≥1000MΩ	
电压驻波比 VSWR	直式 straight	≤1.30
	弯式 right - angle	
材料与涂覆 Mechanical Characteristics		
壳体和其它金属零件 Body or other metallic parts	黄铜镀镍 Brass, nickel plated	
插针 Male center contacts:	黄铜镀金 Brass, gold plated	
插孔 Female center contacts:	铍青铜镀金 Beryllium copper, gold plated	
绝缘体 Insulators:	聚四氟乙烯 PTFE	
压接套 Crimp ferrules:	铜合金镀镍 Copper alloy, nickel	
密封件 Sealing washer	硅橡胶 Silicone rubber	
连接器机械耐久性 Connector durability	500 次 Cycles	

N Series

界面尺寸 Interface Mating Dimensions

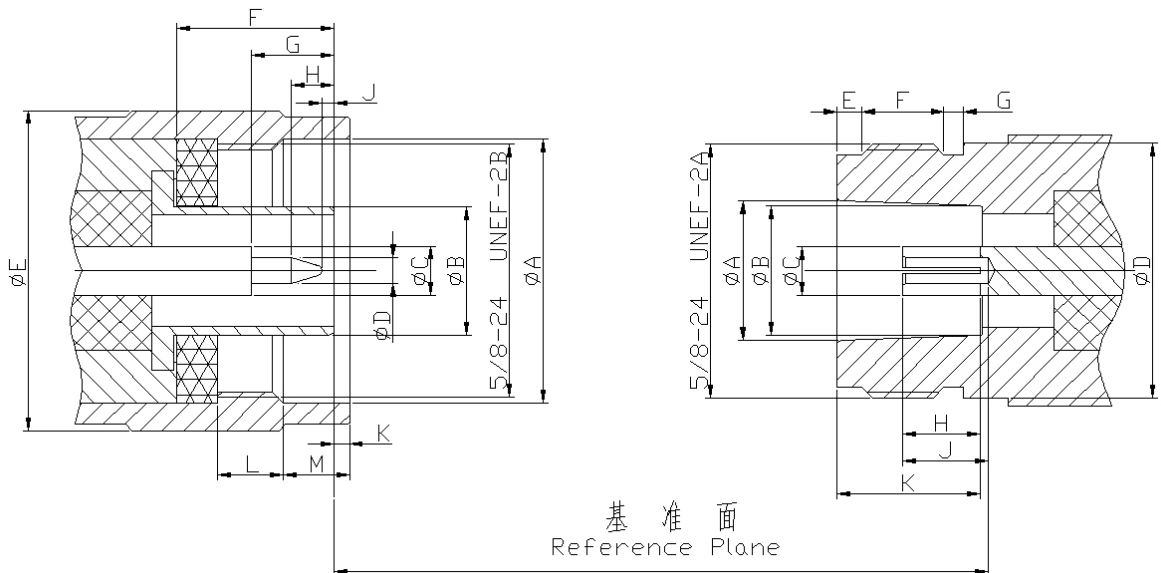

	PLUG (mm)	
	MIN	MAX
A	16.00	-
B	-	8.38
C	3.00	3.15
D	1.60	1.68
E	-	21.00
F	10.11	10.46
G	5.33	5.84
H	3.30	4.32
J	0.08	-
K	0.41	1.52
L	4.50	5.00
M	4.01	4.27

	JACK (mm)	
	MIN	MAX
A	8.53	8.74
B	8.03	8.13
C	3.00	3.15
D	-	15.93
E	1.19	1.96
F	4.37	5.13
G	1.19	1.96
H	4.75	5.26
J	5.33	-
K	9.04	9.19

N Series

半硬、软电缆连接器

Connectors for Semi-Rigid and Flexible Cables



N-KY3Y

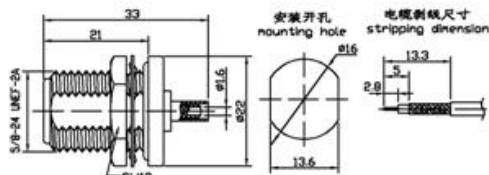

产品型号	电缆型号	备注
N-KY3Y	SFT-50-1.5-1 SYV-50-2-1 RG316/U RG179B/U	



N-KY5Y

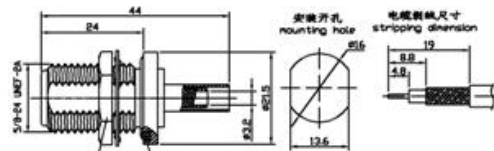

产品型号	电缆型号	备注
N-KY5Y	SFF-50-3-1 RG-141A/U	A 处有密封圈
N-KY5YB	RG-58C/U	A 处无密封圈
N-KY5YA	SFF-50-3-2 RG-142B/U RG-223/U	A 处无密封圈



N-KYB2

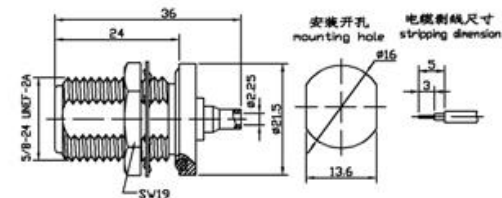

产品型号	电缆型号	备注
N-KYB2	SFT-50-2-1 SMT680-086 RG405/U	



N-KYB3

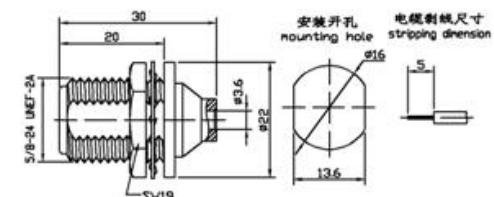

产品型号	电缆型号	备注
N-KYB3	SFT-50-3-1	
N-KYB3C	RG402/U	
N-KYB5	SFT-50-5.2	A 处带密封圈



N-KYH178

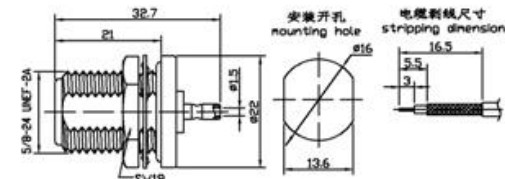

产品型号	电缆型号	备注
N-KYH178	RG178	



N-J4Y

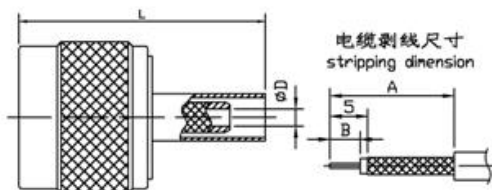

产品型号	电缆型号	A	B	D	L
N-J4Y	SFF-20-2-1	16.5	4.0	Ø2.3	32.7
N-J5Y	SFF-50-3-1 SYV-50-3-1 RG141A/U	15.6	3.5	Ø3.1	32.7
N-J5YA	SFF-50-3-2 RG142/U RG223/U	15.6	3.5	Ø3.1	32.7
N-J6YA	SFF-50-5	16.0	3.5	Ø4.8	35.2



N-J5

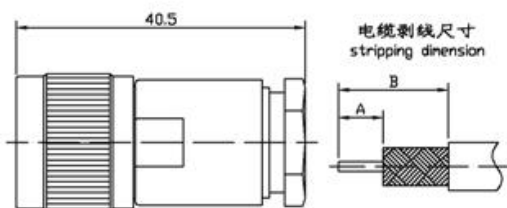

产品型号	电缆型号	A	B
N-J5	SYV-50-3 SFF-50-3-1	7.0	12.0
N-J7	SYV-50-7-1 RG144/U	7.0	11.5
N-J8C	SYV-50-7-2	6.9	11.5
N-J27	SYV-50-5-1 5D-FB	6.9	11.5



N-J9G

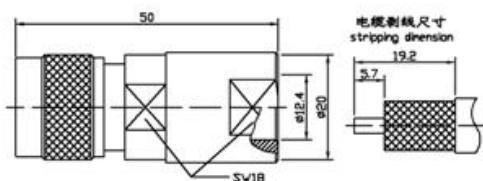

产品型号	电缆型号	备注
N-J9G	SYV-50-9	内导体免焊



N-JB3

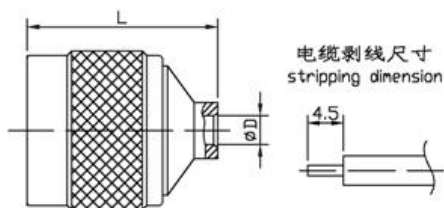

产品型号	电缆型号	L	D	备注
N-JB3	SFT-50-3-1 RG402/U	24.0	Ø3.6	
N-JB3B		24.0	Ø3.6	镀三元合金
N-JB3G		24.0	Ø3.6	不锈钢螺套



N-JW5Y

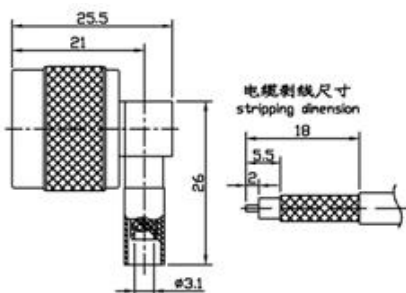

产品型号	电缆型号	备注
N-JW5Y	SYV-50-3 SFF-50-3-1 RG141A/U	
N-JW5YA	SFF-50-3-2 RG142B/U RG223/U	



N-JW7A

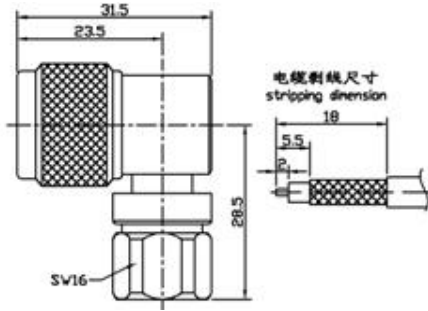

产品型号	电缆型号	备注
N-JW7A	SYV-50-7-1 RG8/U RG213/U	



N-JW8Y

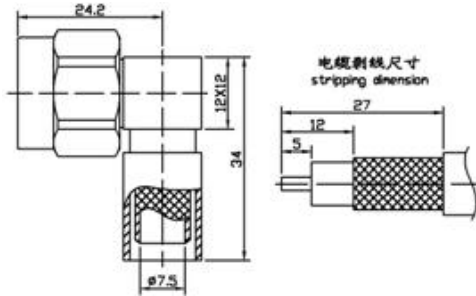

产品型号	电缆型号	备注
N-JW8Y	SYV-50-7-2	镀三元合金



N-JWB3

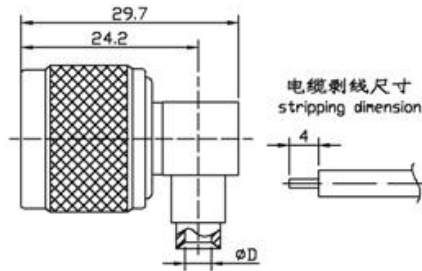

产品型号	电缆型号	D	备注
N-JWB3	SFT-50-3-1 RG402/U	$\phi 3.6$	
N-JWB5A	670-250 SMT680-250	$\phi 6.35$	



N-K3Y

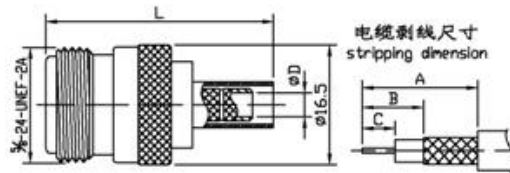

产品型号	电缆型号	A	B	C	L
N-K3Y	SFT-50-1.5-1 SYV-50-2-1 RG316/U	10.8	4.8	2.8	36.0
N-K6Y	SYV-50-5-1	16.0	5.5	3.5	42.0



N-K5YA

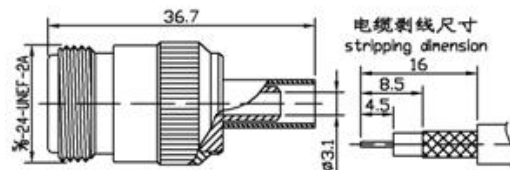

金润信电子科技有限公司



N-KB3

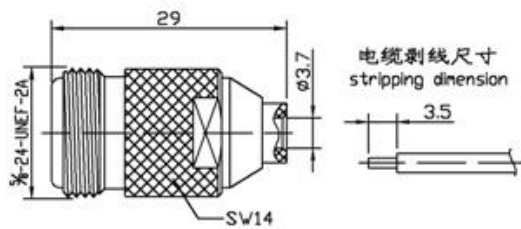

产品型号	电缆型号	备注
N-KB3	SFT-50-3-1 RG402/U	



N-KF3Y

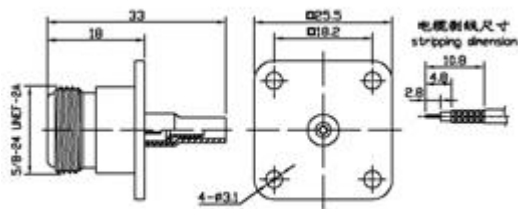

产品型号	电缆型号	备注
N-KF3Y	SFT-50-1.5-1 SYV-50-2-1 RG316/U RG179B/U	



N-KF5Y

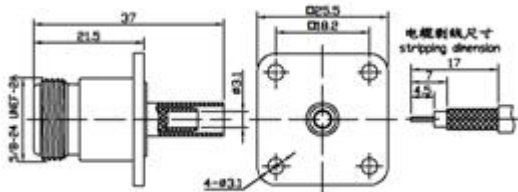

产品型号	电缆型号	备注
N-KF5Y	SFF-50-3-1 RG-141A/U RG-58C/U	



N-KFB2

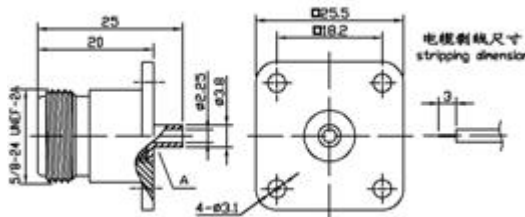

产品型号	电缆型号	备注
N-KFB2	SFT-50-2-1 RG405/U	



N-KFB3

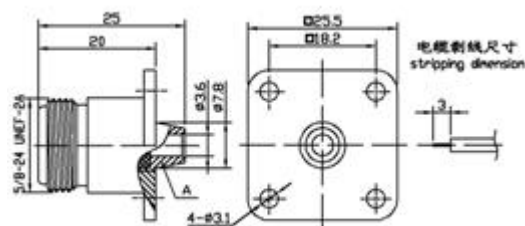

产品型号	电缆型号	备注
N-KFB3	SFT-50-3-1 RG402/U	

波纹铜管电缆连接器
Connectors for Corrugated Copper Tube Cables



N-J1/2

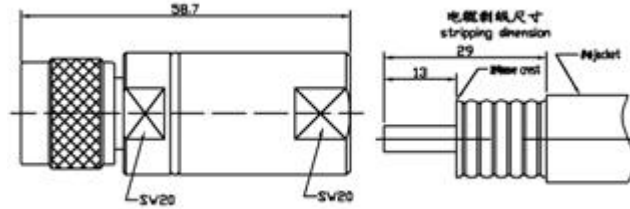

产品型号	电缆型号	备注
N-J1/2	接 1/2' 波纹环形发泡介质电缆	内导体免焊



N-J1/2A

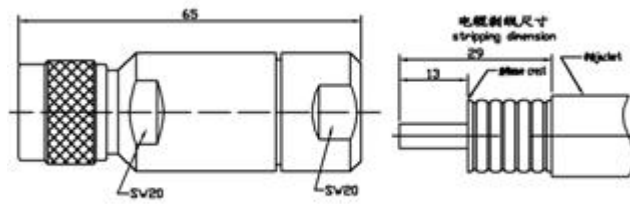

产品型号	电缆型号	备注
N-J1/2A	接 1/2' 波纹环形发泡介质电缆	内导体免焊



N-J7/8

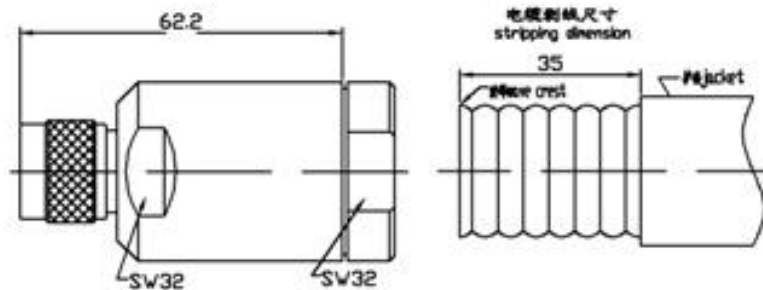

产品型号	电缆型号	备注
N-J7/8	7/8' 波纹铜管 (环形) 介质发泡电缆	内导体免焊



N-K7/8

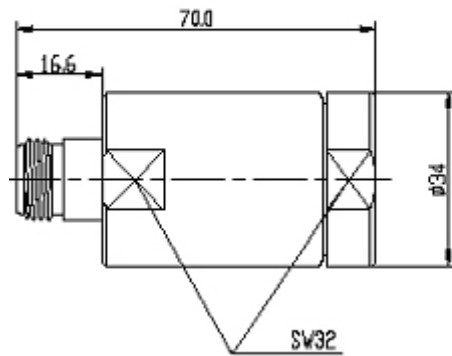

剥线尺寸
stripping dimension

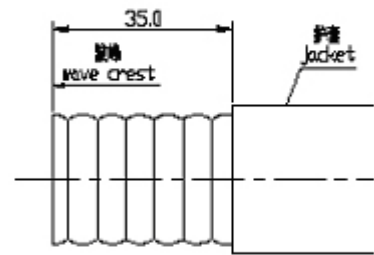

产品型号	电缆型号	备注
N-K7/8	7/8" 波纹铜管 (环形) 介质发泡电缆	内导体免焊

法兰安装式终端连接器

Flange Connectors with Solder End



N-JFD1

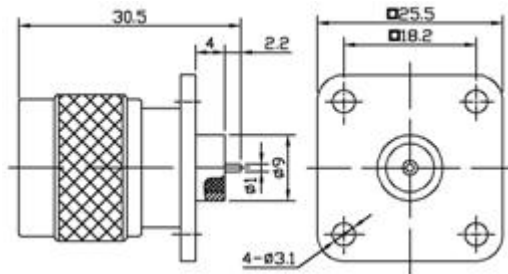

N-JFD1A

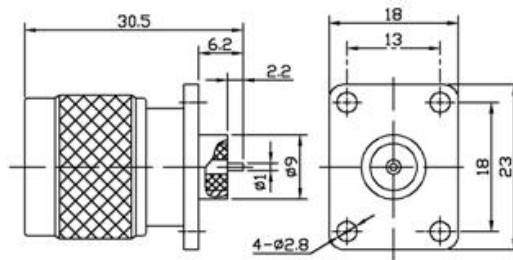

N-KFD

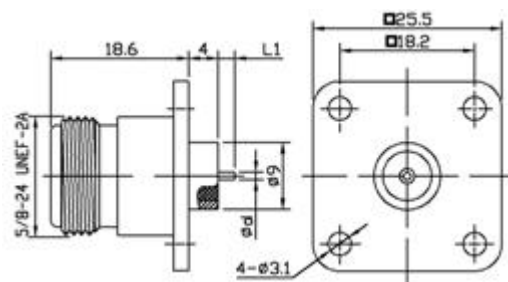

产品型号	L1	d	备注
N-KFD	2.2	$\phi 1.0$	
N-KFD6	11.0	$\phi 2.0$	
N-KFD6A	2.2	$\phi 1.0$	外壳镀银
N-KFD6D	11.0	$\phi 1.0$	
N-KFD13	2.2	$\phi 1.0$	法兰有沉孔



N-KFD1

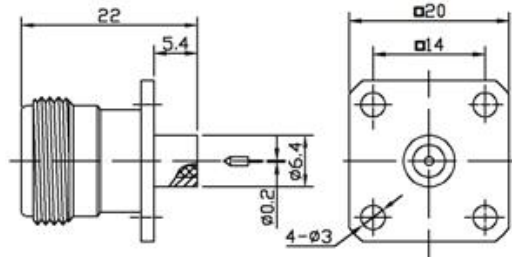

产品型号	备注
N-KFD1	后端配插针



N-KFD2

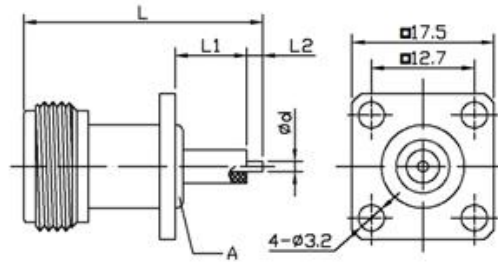

产品型号	L	L1	L2	d	备注
N-KFD2	23.5	8.8	2.0	Ø1.3	带密封圈
N-KFD3	41.5	18.8	4.0	Ø1.3	
N-KFD11	36.5	15.0	3.0	Ø1.2	
N-KFD12	29.3	9.5	1.3	Ø1.3	
N-KFD19	45.7	25.0	2.0	Ø1.3	带密封圈
N-KFD20	29.8	9.3	1.7	Ø1.3	
N-KFD21	78.7	58.0	2.0	Ø1.5	
N-KFD22	30.1	5.1	6.3	Ø1.3	



N-KFD4

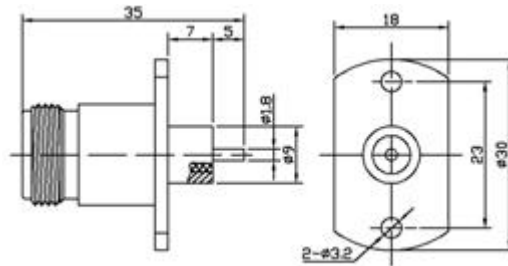

N-KFD5

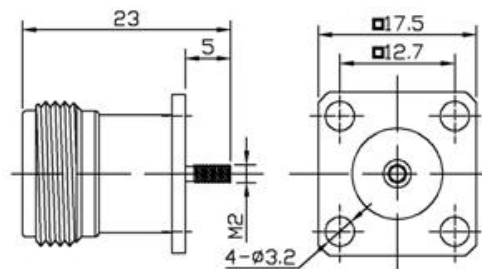

N-KFD6C

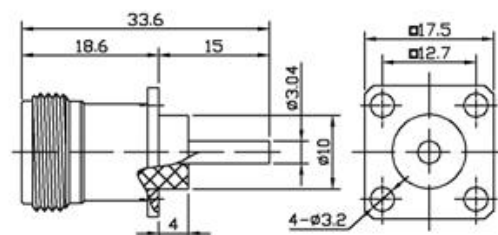



N-KFD10

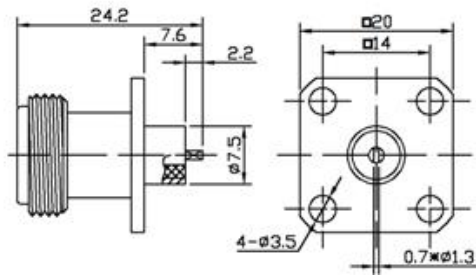

N-KFD11

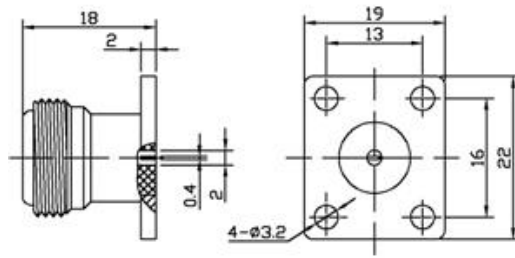

N-KFD17

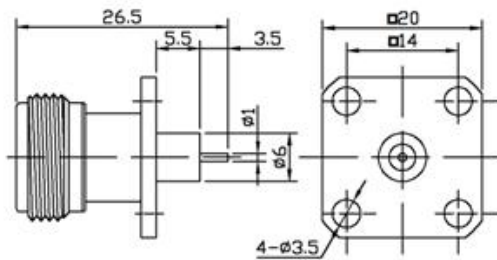

产品型号	备注
N-KFD17	后端配插针



N-KFD18

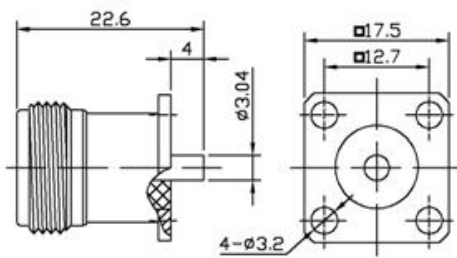

N-KFD31

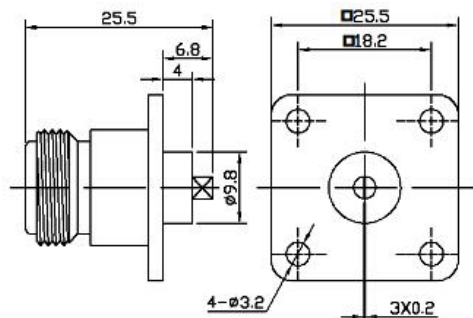



N-KFD38

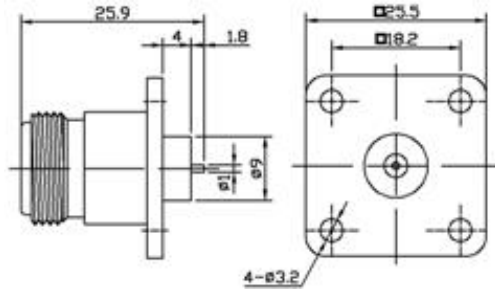

N-KFD45

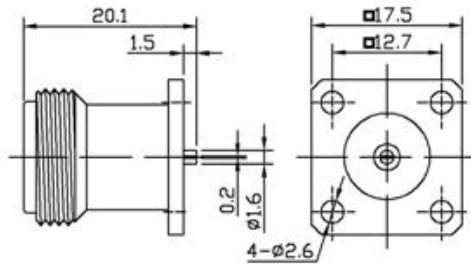

N-KFD48

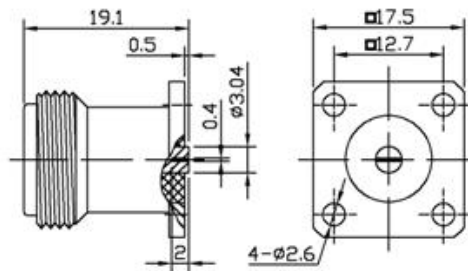

穿孔安装式终端连接器

Perforations Connectors with Solder End



N-50KY

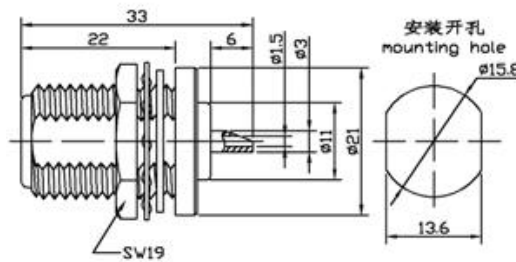

N-JYD

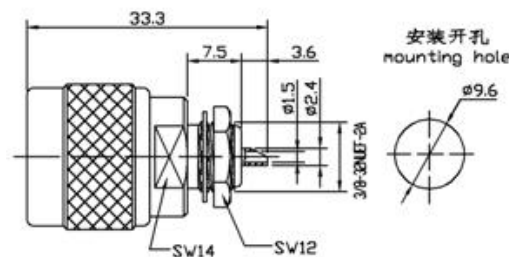



N-JYD

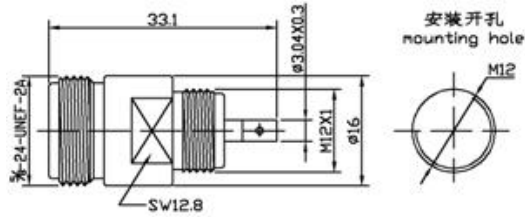

印制板安装连接器
Connectors for PC Board Mounting



N-50KF-PCB

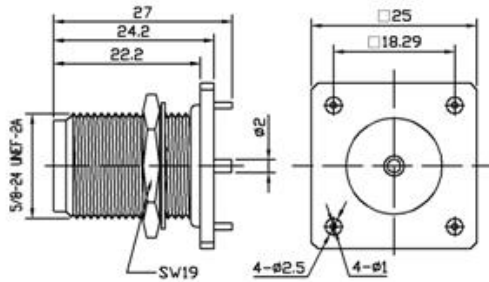

N-50KHD

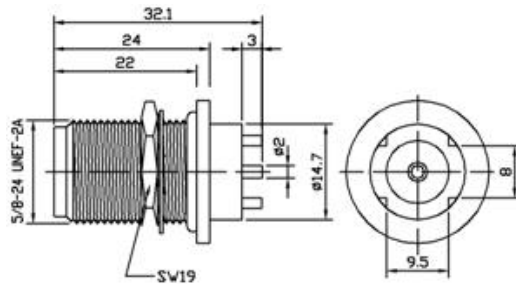

系列内转接器
Within-Series Adapters



N-50JK

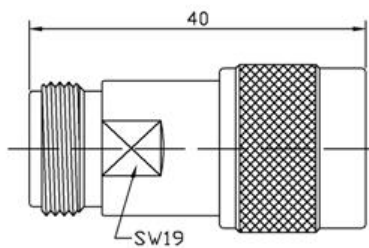

N-50KFK

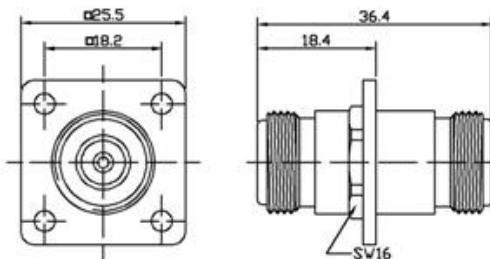



N-JWJ

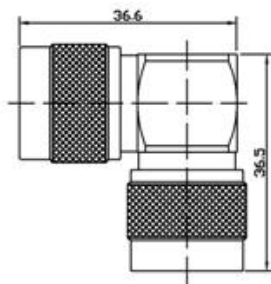

N-JWK

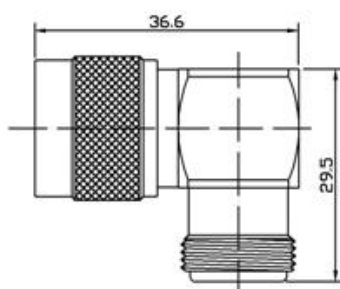

N-KK

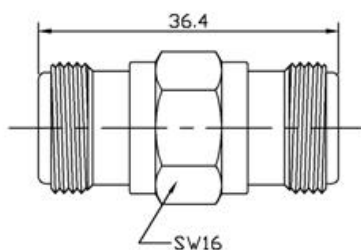

N-KYK

