

BMA Series

BMA 连接器又称盲插连接器，从结构尺寸上讲是 SMA 系列的推入式变形，接口界面采用空气界面，使用频率高，体积小接触可靠，广泛应用于模块化整机产品中模块的互连。

BMA is also called blind insert connectors. In structure size, it is the push transmutation of SMA series and adopts air interface, small size and reliable contact, widely used for interconnection of module in the whole modularization product.

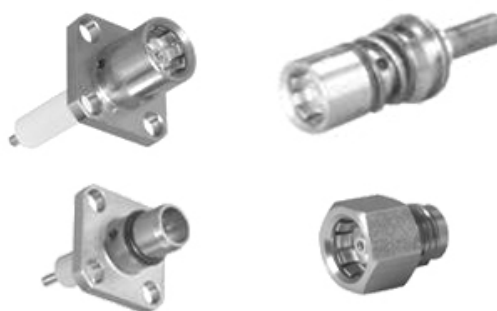

金润信电子科技有限公司

主要技术特性 Technical Characteristics:		
环境温度范围 Temperature range	-65~+155°C	
电气性能 Electrical Characteristics		
特征阻抗 Characteristic impedance	50Ω	
工作电压 Working voltage	250V max(有效值)	
频率范围 Frequency range	0~22GHz	
介质耐压 Dielectric withstanding voltage	海平面 at sea level: 1500V(volts RMS)	
接触电阻 Contact resistance	内导体 center contact	≤2.0mΩ
	外导体 Outer contact	≤2.0mΩ
绝缘电阻 Insulation resistance	≥5000MΩ	
电压驻波比 VSWR	≤1.30	
材料与涂覆 Mechanical Characteristics		
壳体和其他金属零件 Body or other metallic parts	黄铜镀金或镀镍 Brass, gold or nickel plated 不锈钢, 钝化或镀金 stainless, steel passivity or gold plated	
插针 Male center contacts:	黄铜镀金 Brass, gold plated	
插孔 Female center contacts:	铍青铜镀金 Beryllium copper, gold plated	
绝缘体 Insulators:	聚四氟乙烯 PTFE	
密封件 Sealing washer	硅橡胶 Silicone rubber	
连接器机械耐久性 Connector durability	1000 次 Cycles	

界面尺寸 Interface Mating Dimensions

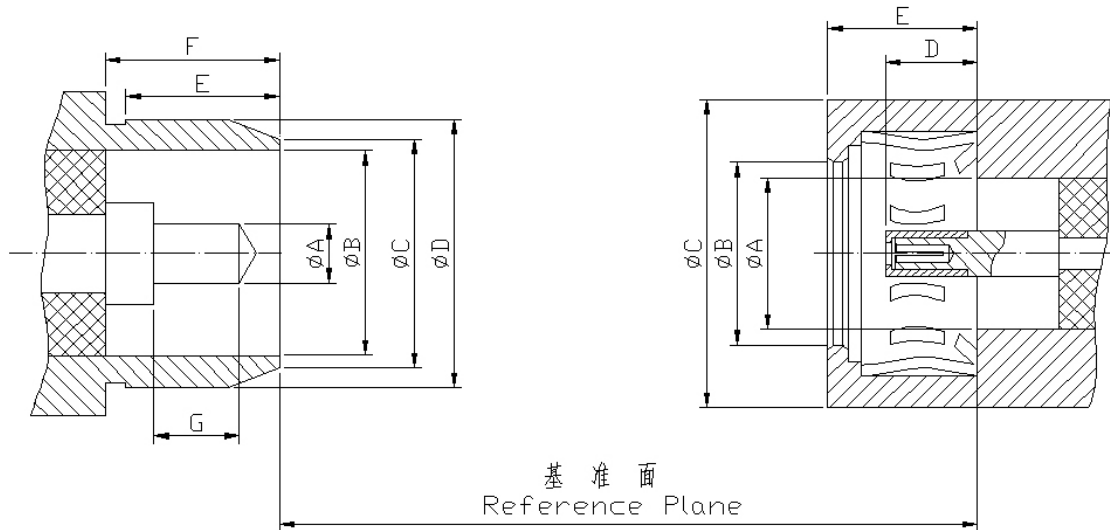

	PLUG (mm)	
	MIN	MAX
A	0.9	0.94
B	-	4.09
C	-	4.9
D	5.31	5.36
E	3.25	3.42
F	5.05	-
G	1.35	-

	JACK (mm)	
	MIN	MAX
A	-	4.09
B	5.72	-
C	7.37	-
D	3.05	3.2
E	-	5.03

BMA Series

电缆连接器 Connectors for Cables

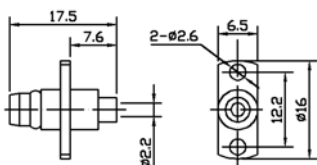

电缆剥线尺寸
stripping dimension

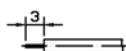

BMA-JFB2

产品型号	电缆型号	备注
BMA-JFB2	SFT-50-2-1 RG405/U	

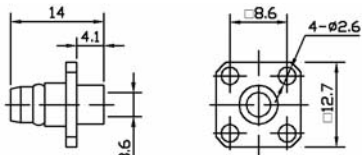
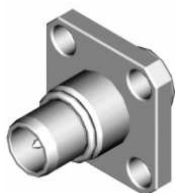

电缆剥线尺寸
stripping dimension

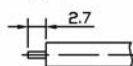

BMA-JFB3

产品型号	电缆型号	备注
BMA-JFB3	SFT-50-3-1 RG402/U	

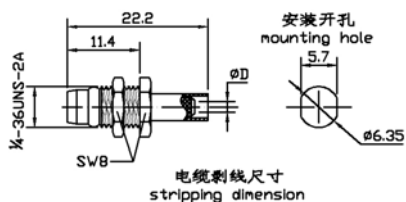

电缆剥线尺寸
stripping dimension

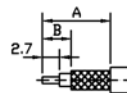

BMA-JY3

产品型号	电缆型号	D	A	B
BMA-JY3	SFF-50-1.5-1 RG316/U	Ø1.6	10.0	4.5
BMA-JY5	SFF-50-3-1 RG141/A	Ø3.1	11.7	4.0

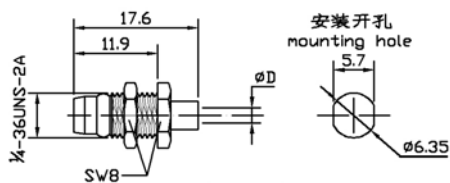

电缆剥线尺寸
stripping dimension

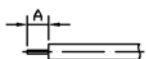

BMA-JYB2

产品型号	电缆型号	D	A
BMA-JYB2	SFT-50-2-1 RG405/U	Ø2.2	3.2
BMA-JYB3	SFT-50-3-1 RG402/U	Ø3.6	2.8

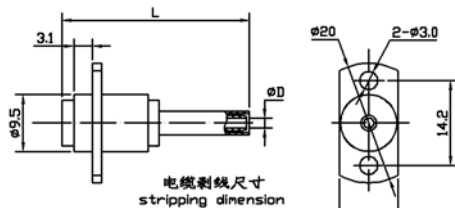

电缆剥线尺寸
stripping dimension



BMA-KF3

产品型号	电缆型号	L	A	B	D
BMA-KF3	SFF-50-1.5-1 RG316/U	29.8	11.4	3.9	Ø1.6
BMA-KF4	SFF-50-2-1	31.1	12.7	5.0	Ø2.3
BMA-KF5A	SFF-50-3-2 RG142B/U	31.8	13.7	3.7	Ø3.1



BMA-KFB2

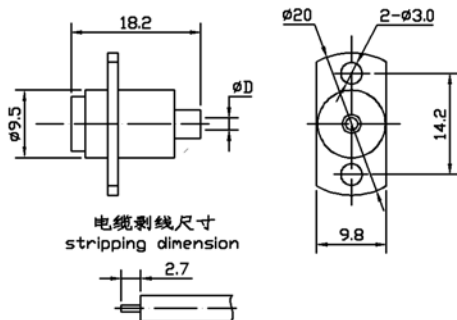

产品型号	电缆型号	D	备注
BMA-KFB2	SFT-50-2-1 RG405/U	Ø2.2	
BMA-KFB3	SFT-50-3-1 RG402/U	Ø3.6	
BMA-KFB3-G		Ø3.6	不锈钢 法兰外壳



BMA-KY3

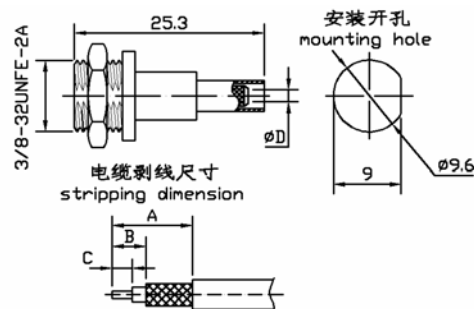

产品型号	电缆型号	A	B	C	D
BMA-KY3	SFF-50-1.5-1 RG316/U	9.5	4.5	2.7	Ø1.6
BMA-KY4A	SFF-50-2-2	12.3	4.5	2.7	Ø2.3
BMA-KY5	SFF-50-3-1 RG141/A	19.0	8.5	4.0	Ø3.1



BMA-KYB2

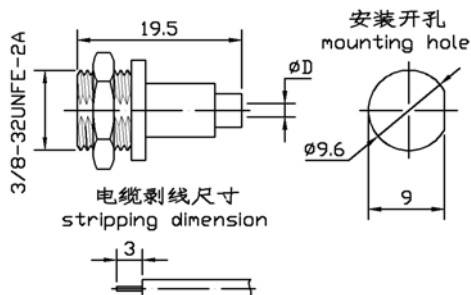

产品型号	电缆型号	d
BMA-KYB2	SFT-50-2-1 RG405/U	Ø2.2
BMA-KYB3	SFT-50-3-1 RG402/U	Ø3.6

法兰安装式终端连接器
Flange Connectors with Solder End



BMA-JFD

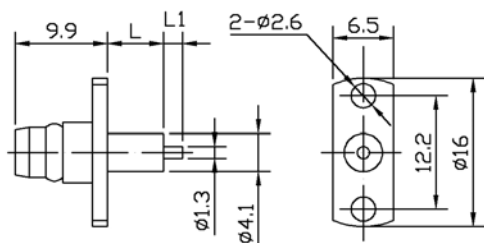

产品型号	L	L1
BMA-JFD	3.2	2.0
BMA-JFD6	8.4	4.0
BMA-JFD7	6.0	2.0

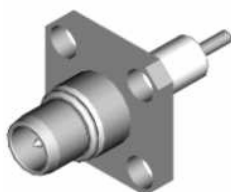

BMA-JFD1

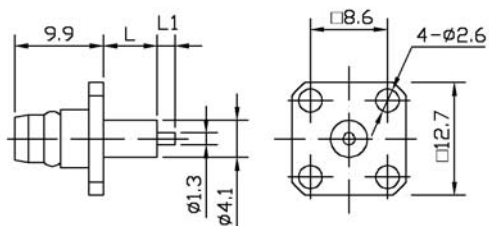

产品型号	L	L1
BMA-JFD1	8.4	3.0
BMA-JFD3	4.0	2.0
BMA-JFD4	0	3.0
BMA-JFD8	3.2	2.8



BMA-JFD2

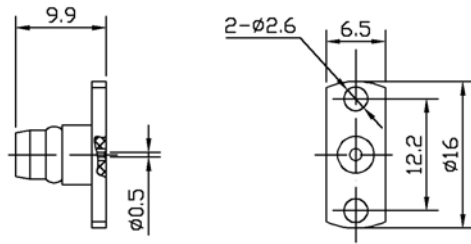

产品型号	备注
BMA-JFD2	适配插针 00.5 ^{-0.001} _{-0.052}



BMA-JFD4

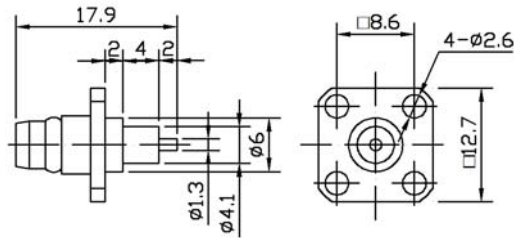

BMA-JFD9

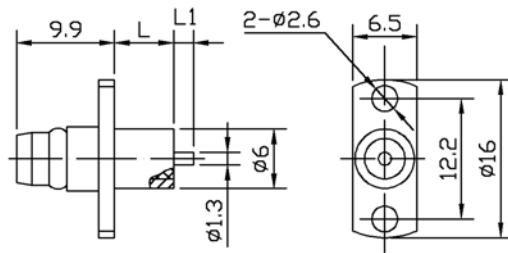

产品型号	L	L1
BMA-JFD9	5.6	2.0
BMA-JFD9A	3.6	3.6
BMA-JFD15	4.0	2.0
BMA-JFD16	3.2	1.5



BMA-KFD1

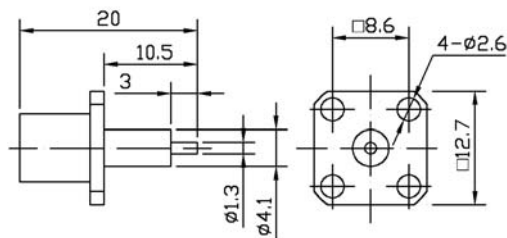

BMA-KFD2

